



SF21 THRU SF28

Superfast Recovery Rectifiers

FEATURES

- High surge capability
- Low forward voltage, high current capability
- Hermetically sealed
- Superfast recovery times
- Exceeds environmental standards of MIL-S-19500/228
- Low leakage.

MECHANICAL DATA

Case: Molded plastic, DO-15
 Epoxy: UL 94V-O rate flame retardant
 Lead: Axial leads, solderable per MIL-STD-202, method 208 guaranteed
 Polarity: Color band denotes cathode end
 Mounting position: Any
 Weight: 0.015ounce, 0.4gram

DO-15

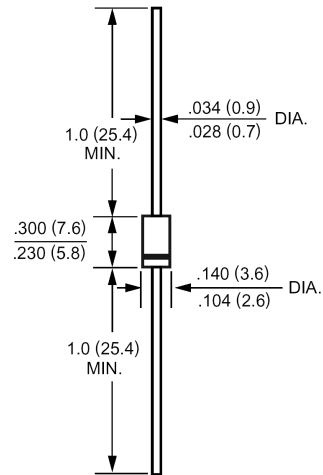

Dimensions in inches and (millimeters)

Maximum Ratings and Electrical Characteristics

Ratings at 25 °C ambient temperature unless otherwise specified.
 Single phase, half wave, 60Hz, resistive or inductive load.
 For capacitive load, derate current by 20%.

	Symbols	SF21	SF22	SF23	SF24	SF25	SF26	SF28	Units	
Maximum Recurrent Peak Reverse Voltage	V_{RRM}	50	100	150	200	300	400	600	Volts	
Maximum RMS Voltage	V_{RMS}	35	70	105	140	210	280	420	Volts	
Maximum DC Blocking Voltage	V_{DC}	50	100	150	200	300	400	600	Volts	
Maximum Average Forward Rectified Current .375"(9.5mm) Lead Length at $T_A=55$	$I_{(AV)}$	2.0							Amp	
Peak Forward Surge Current, 8.3ms single half-sine-wave superimposed on rated load (JEDEC method)	I_{FSM}	50							Amp	
Maximum Forward Voltage at 2.0A DC and 25	V_F	1.0			1.25		1.65		Volts	
Maximum Reverse Current at $T_A=25$ at Rated DC Blocking Voltage $T_A=100$	I_R	5.0			500					uAmp
Typical Junction Capacitance (Note 1)	C_J	60			30					pF
Typical Thermal Resistance (Note 2)	$R_{\theta JA}$	40							/W	
Maximum Reverse Recovery Time (Note 3)	T_{RR}	35							nS	
Operating Junction Temperature Range	T_J	-55 to +125								
Storage Temperature Range	T_{stg}	-55 to +125								

NOTES:

- 1- Measured at 1 MHz and applied reverse voltage of 4.0 VDC.
- 2- Thermal Resistance from Junction to Ambient 0.375"(9.5mm) lead length P.C.B. Mounted.
- 3- Reverse Recovery Test Conditions : $I_F=.5A$, $I_R=1A$, $I_{RR}=.25A$.



SF21 THRU SF28

Superfast Recovery Rectifiers

RATINGS AND CHARACTERISTIC CURVES

FIG.1- REVERSE RECOVERY TIME CHARACTERISTIC AND TEST CIRCUIT DIAGRAM

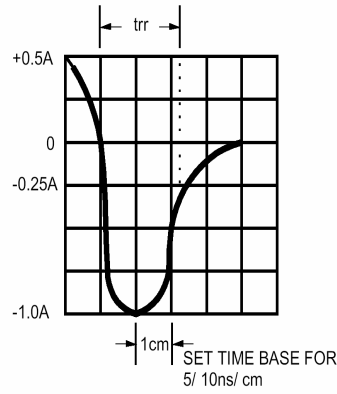
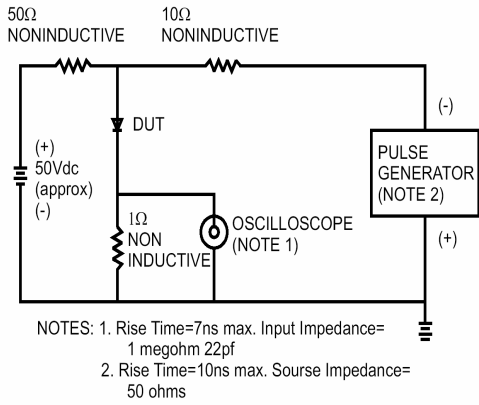

FIG.2- MAXIMUM AVERAGE FORWARD CURRENT DERATING

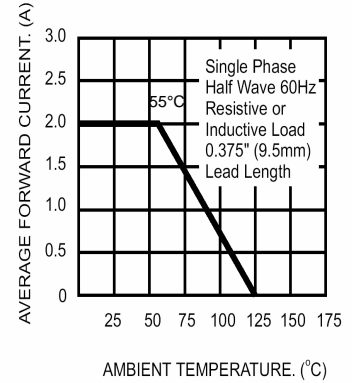

FIG.3- TYPICAL REVERSE CHARACTERISTICS

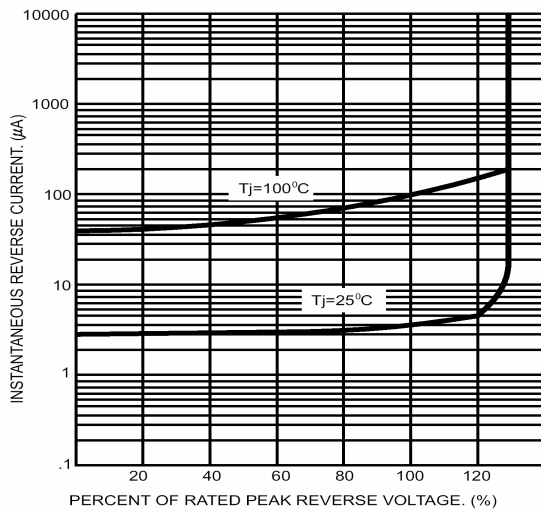

FIG.4- TYPICAL FORWARD CHARACTERISTICS

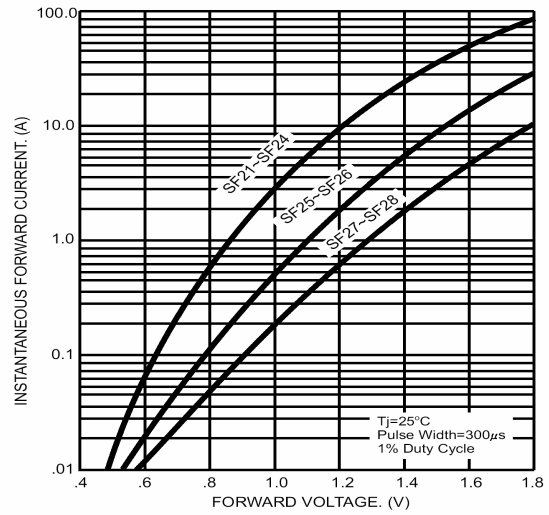

FIG.5- MAXIMUM NON-REPETITIVE FORWARD SURGE CURRENT

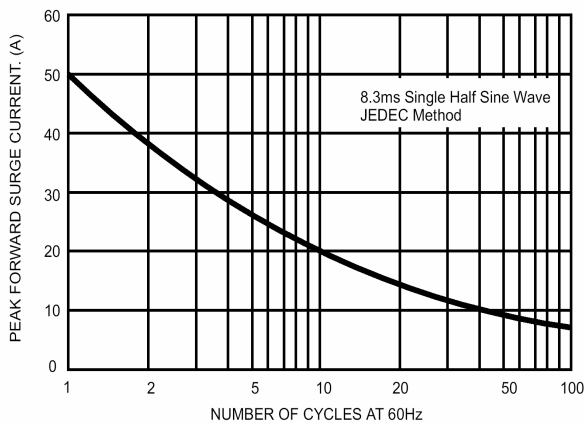

FIG.6- TYPICAL JUNCTION CAPACITANCE

